

LYNXTechnik AG

Broadcast Television Equipment

Reference Manual

C DX 3610

SD/HD Monitoring Down Converter with Video D/A Conversion

**Revision 1.7
December 2006**



Information in this document is subject to change without notice. No part of this document may be reproduced or transmitted in any form or by any means, electronic or mechanical for any purpose, without express written permission of LYNX Technik AG.

LYNX Technik AG may have patents, patent applications, trademarks, copyrights or other intellectual property rights covering the subject matter in this document. Except as expressly written by LYNX Technik AG, the furnishing of this document does not give you any license to patents, trademarks, copyrights or other intellectual property of LYNX Technik AG or any of its affiliates.

**LYNX Technik AG
Brunnenweg 3
D 64331 Weiterstadt
Germany
www.lynx-technik.com**

Contents

WARRANTY	3
REGULATORY INFORMATION	4
EUROPE.....	4
<i>Declaration of Conformity.....</i>	4
USA.....	4
<i>FCC 47 Part 15.....</i>	4
GETTING STARTED.....	5
PACKAGING.....	5
PRODUCT DESCRIPTION.....	5
INPUT FORMATS	5
OUTPUT FORMATS	5
CONVERSION MODES	5
<i>HDTV Inputs > Down Conversion.....</i>	5
<i>SDTV Inputs.....</i>	6
ASPECT RATIOS	6
<i>Letterbox.....</i>	6
<i>Center Cut.....</i>	6
<i>Stretch to Fill.....</i>	6
VIDEO PROCESSING	7
<i>Video Proc Amp.....</i>	7
<i>Aperture Correction and Color Space Conversion.....</i>	7
AUDIO PROCESSING	7
TEST PATTERNS.....	7
FUNCTIONAL DIAGRAM	8
MODULE LAYOUT.....	8
CONNECTIONS	9
VIDEO	9
POWER	9
INSTALLATION.....	10
SWITCH SETTINGS.....	10
SWITCH FUNCTIONS	12
<i>Switch 1.....</i>	12
<i>Switch 2 / 3.....</i>	12
<i>Switch 4.....</i>	12
<i>Switch 5.....</i>	12
<i>Switch 6.....</i>	12
<i>Switch 7 / 8.....</i>	12
FACTORY DEFAULT SETTINGS.....	12
INDICATORS.....	12
ALARM INDICATOR	12
MODULE LED.....	13
GUI OPERATION	13
MAIN TAB.....	14
ANALOG VIDEO TAB.....	16
ANALOG VIDEO GAIN TAB	20
SPECIFICATIONS.....	22
SERVICE	23
PARTS LIST	23
TECHNICAL SUPPORT	23
CONTACT INFORMATION	23

Warranty

LYNX Technik AG warrants that the product will be free from defects in materials and workmanship for a period of two (2) year from the date of shipment. If this product proves defective during the warranty period, LYNX Technik AG at its option will either repair the defective product without charge for parts and labor, or will provide a replacement in exchange for the defective product.

In order to obtain service under this warranty, customer must notify LYNX Technik of the defect before expiration of the warranty period and make suitable arrangements for the performance of service. Customer shall be responsible for packaging and shipping the defective product to the service center designated by LYNX Technik, with shipping charges prepaid. LYNX Technik shall pay for the return of the product to the customer if the shipment is within the country which the LYNX Technik service center is located. Customer shall be responsible for payment of all shipping charges, duties, taxes and any other charges for products returned to any other locations.

This warranty shall not apply to any defect, failure, or damage caused by improper use or improper or inadequate maintenance and care. LYNX Technik shall not be obligated to furnish service under this warranty a) to repair damage resulting from attempts by personnel other than LYNX Technik representatives to install, repair or service the product; b) to repair damage resulting from improper use or connection to incompatible equipment; c) to repair any damage or malfunction caused by the use of non LYNX Technik supplies; or d) to service a product which has been modified or integrated with other products when the effect of such modification or integration increases the time or difficulty servicing the product.

THIS WARRANTY IS GIVEN BY LYNX TECHNIK WITH RESPECT TO THIS PRODUCT IN LIEU OF ANY OTHER WARRANTIES, EXPRESS OR IMPLIED. LYNX TECHNIK AND ITS VENDORS DISCLAIM ANY IMPLIED WARRANTIES OF MERCHANTABILITY OR FITNESS FOR A PARTICULAR PURPOSE. LYNX TECHNIK'S RESPONSIBILITY TO REPAIR AND REPLACE DEFECTIVE PRODUCTS IS THE SOLE AND EXCLUSIVE REMEDY PROVIDED TO THE CUSTOMER FOR BREACH OF THIS WARRANTY. LYNX TECHNIK AND ITS VENDORS WILL NOT BE LIABLE FOR ANY INDIRECT, SPECIAL, INCIDENTAL, OR CONSEQUENTIAL DAMAGES IRRESPECTIVE OF WHETHER LYNX TECHNIK OR THE VENDOR HAS ADVANCE NOTICE OF THE POSSIBILITY OF SUCH DAMAGES.

Regulatory information

Europe

Declaration of Conformity

We	LYNX Technik AG Brunnenweg 3 D-64331 Weiterstadt Germany
<i>Declare under our sole responsibility that the product</i>	
TYPE: C DX 3610	
<i>To which this declaration relates is in conformity with the following standards (environments E1-E3):</i>	
EN 55103-1 /1996	
EN 55103-2 /1996	
EN 60950 /2001	
<i>Following the provisions of 89/336/EEC and 73/23/EEC directives.</i>	
	Winfried Deckelmann
Weiterstadt, November 2006	
<i>Place and date of issue</i>	<i>Legal Signature</i>

USA

FCC 47 Part 15

This device complies with part 15 of the FCC Rules. Operation is subject to the following two conditions: (1) This device may not cause harmful interference, and (2) this device must accept any interference received, including interference that may cause undesired operation.

Note: This equipment has been tested and found to comply with the limits for a Class A digital device, pursuant to the part 15 of the FCC Rules. These limits are designed to provide reasonable protection against harmful interference when the equipment is operated in a commercial environment. This equipment generates, uses, and can radiate radio frequency energy and, if not installed and used in accordance with the instruction manual, may cause harmful interference to radio communications. Operation of this equipment in a residential area is likely to cause harmful interference in which case the user will be required to correct the interference at his own expense

Getting Started

Packaging

The shipping carton and packaging materials provide protection for the module during transit. Please retain the re-useable shipping cartons for a period of time in case subsequent shipping of the product becomes necessary. Please read this manual before attempting operation of the module.

Product Description

The C DX 3610 is a high quality multi-format monitoring down converter providing down converted digital and analog video outputs (with no embedded or external audio support).

Input Formats

The module has one multi-format serial digital input with automatic input detection. The module will detect the following input standards and configure the input stage automatically for operation in the connected format.

SDTV Formats	HDTV Formats
525 / 59.94Hz	1080i / 59.94Hz
625 / 50Hz	1080i / 60Hz
	1080i / 50Hz
	720P / 59.94Hz
	720P / 60Hz
	720P / 50Hz

Output Formats

The module provides analog and digital video outputs. The analog video outputs are SDTV only and the available 3 BNC connections can be configured to provide the following analog video outputs.

- 3 x CVBS (composite)**
- 1 x YUV Component analog video**
- 1 x YC (S-VHS) + 1 x CVBS (composite)**

Two serial digital outputs are also provided which can be configured to provide 2 x digital down converted outputs or 2 x re-clocked copies of the input signal (1>2 distribution amplifier)

Conversion Modes

HDTV Inputs > Down Conversion

With a compatible HD source connected the module only supports down conversion between divisible frame rates. For example If a frame rate of 59.94Hz is connected to the input then the module can only output a down converted 59.94Hz output. This module will not function as standards converter.

Please refer to the table below which shows compatible conversion modes

Input Signal	Converted Output	Notes
1080i / 50Hz	625 / 50Hz	
1080i / 59.94Hz	525 / 59.94Hz	
1080i / 60Hz	525 / 59.94Hz	59.94Hz output will drop frame
720P / 50Hz	625 / 50Hz	
720P / 59.94Hz	525 / 59.94Hz	
720P / 60Hz	525 / 59.94Hz	59.94Hz output will drop frame

Note. It is possible to convert between 60Hz and 59.94Hz. The resulting cumulative error will result in dropped frames on the converted outputs.

SDTV Inputs

When a SDTV input is detected the module functions as a D/A converter + distribution amplifier providing analog and digital outputs of the connected SDTV input signal.

Aspect Ratios

The module supports three aspect ratio conversion modes which can be user selected using dip switches or preset with the optional control system.

Letterbox

This takes the 16:9 aspect ratio of the input HD signal and fits it into the 4:3 SD aspect ratio screen with black bars at the top and bottom of the image.

Center Cut

This mode cuts the center portion of the 16:9 input signal and fills the 4:3 SD aspect ratio screen.

Stretch to Fill

This mode takes the 16:9 input signal and distorts (vertically stretches) the image to fit the available 4:3 SD aspect ratio space.



16:9 HDTV Source



4:3 Center Cut



4:3 Letterbox



4:3 Stretch to fill

Video Processing

Note. All digital signal processing and D/A conversion is 10 bit.

Video Proc Amp

A basic video proc amp is provided for video adjustments. This provides for adjustable Luminance Gain / Chrominance Gain and Pedestal (Lift).

Note. Proc amp functions are preset to null. These parameters are only adjustable via the central control system or by using the RCT 3002 Service Adapter. Please refer to page 13 for illustrations of the available GUI controls

Aperture Correction and Color Space Conversion

Adjustable horizontal aperture correction is provided as well as selectable 709 > 601 color space (gamut) conversion. Color space conversion can be set to convert or transparent modes. In transparent mode the color space is passed from the input to the output.

Note. Horizontal Aperture correction is factory preset for a flat frequency response on the SDTV outputs. (The down conversion filtering process results in a slight roll off in high frequencies). The amount of aperture correction applied is user adjustable via the central control system or RCT 3002 Service Adapter. Please refer to page 13 for illustrations of the available GUI controls.

All module settings are automatically stored in internal flash ram and will survive power cycles and long term storage. The settings specified above can be changed and stored into flash ram with the optional RCT 3002 USB Service Adapter.

Audio Processing

No audio support is provided on this module. Any audio which is embedded in the incoming SDI stream will not be processed and no embedded audio is present on the down converted digital outputs.

If the module is configured to pass the input signal to the two SDI outputs then any embedded audio is preserved.

Test Patterns

The module contains a selection of video test patterns which can be used for testing and fault finding. Patterns provided are 75% Colorbars, 75% Colorbars over Red, Full Field Black, Pathological PLL/EQ and Full field Blue (blue screen). Test patterns are provided on the analog and Digital video outputs in the selected format. If configured to pass the input HDTV to the digital outputs then both a Digital HD Test patterns and an Analog SDTV patterns are provided.

By pre-selecting the input format (with no input connected) the Module can be used as a stand alone multi-format Test Pattern Generator.

Functional Diagram

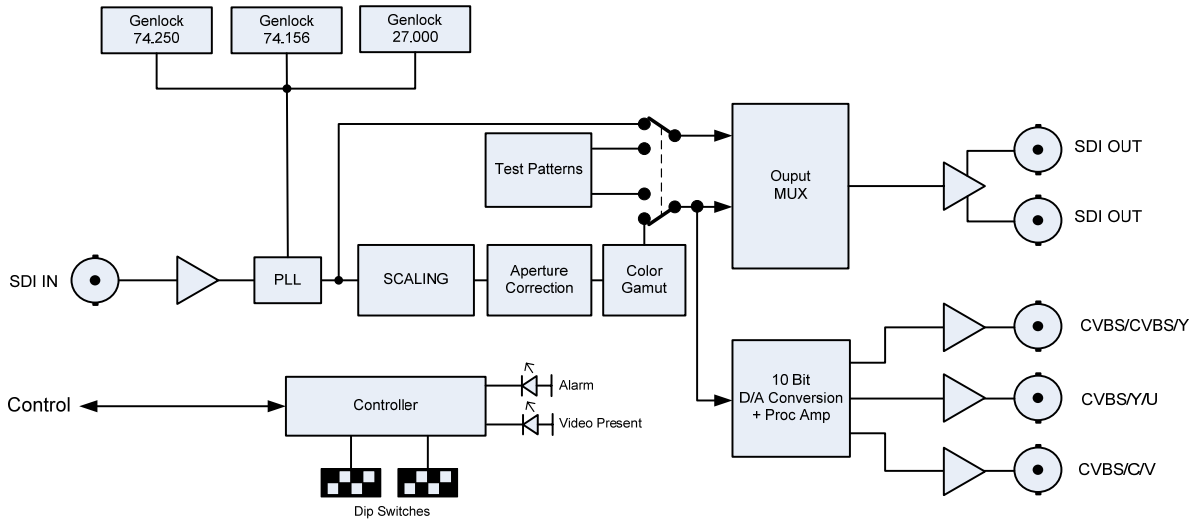

Module Layout

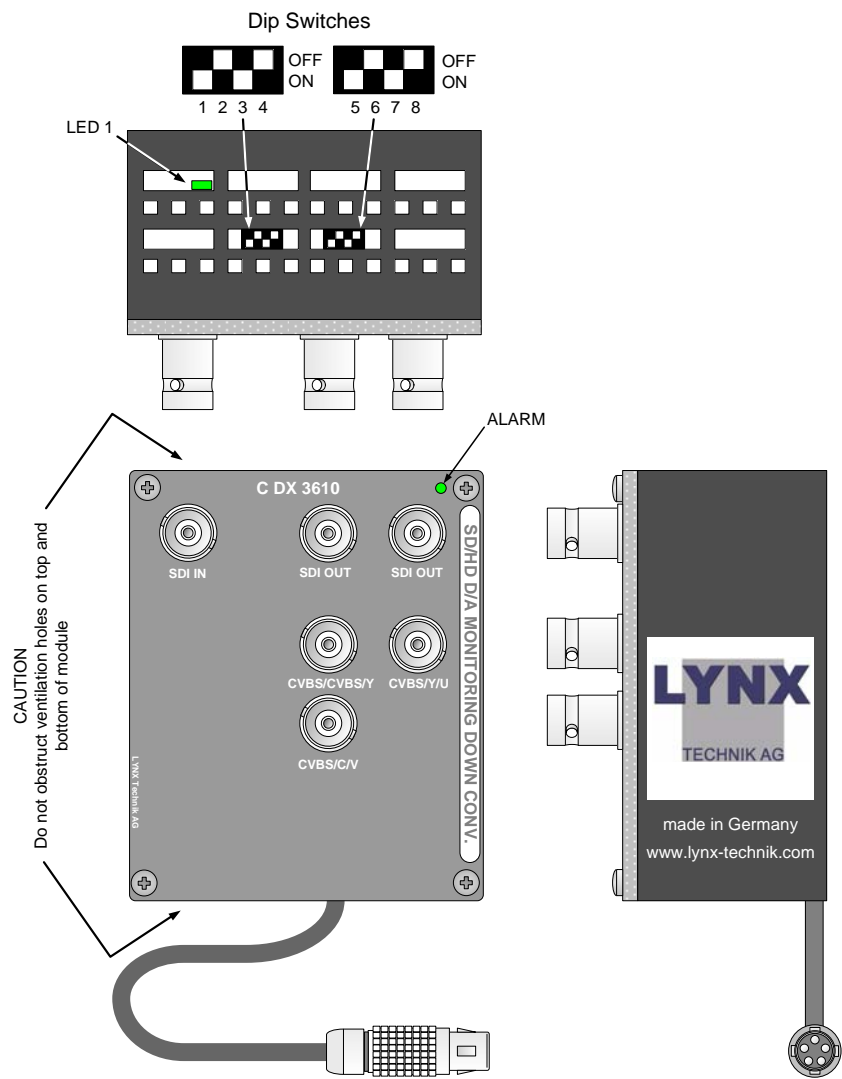

Connections

Video

The C DX 3610 uses standard 75 Ohm BNC connectors. We recommend the use of high quality video cable for digital video connections to reduce the risk of errors due to excessive cable attenuation. Max cable lengths the module will support are shown below.

SDTV = 250m Belden 8281 (270Mbits/s)

HDTV = 140m Belden 1694A (1.4Gbits/s)

Power

The module requires a + 5VDC power supply. There are various power options available by LYNX which includes AC power adapters and various battery adapters. Please refer to the LYNX catalog for more details on available power supply options.

The connector used on the module is a LEMO connector which connects both power and data connections to the module. Connection information is shown below. The data interface is used for the optional central control system or RCT 3002 USB Service Adapter.

The LEMO connector has a metal key and can be aligned by using the red dots on both connectors and then pushed together until locked into place. When connected correctly this will provide a secure mechanical connection.

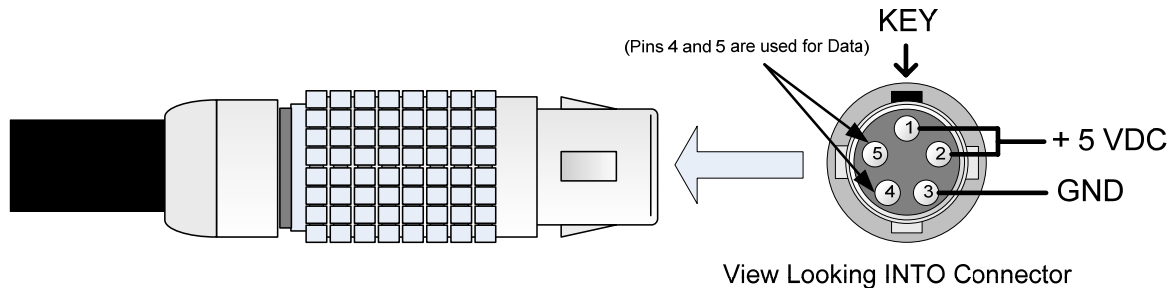

If you are providing your own power source please ensure it can provide enough power and provides a clean + 5VDC supply with a tolerance of + 4.95VDC to +5.10 VDC (under load measured at the connector). We recommend the use of screened power cable connecting the screen to the ground pin.

DO NOT MAKE ANY CONNECTIONS TO PINS 4 and 5 AS THESE ARE FOR DATA CONNECTIONS (LYNX USE ONLY). CONNECTING POWER TO THESE PINS WILL RESULT IN MODULE DAMAGE.

A suitable mating connector may be purchased directly from LYNX or LEMO directly www.lemo.com. Lemo Part number for mating connector is **FGG.0B.305.CLAD42**

Note

Any failure or damage to the module resulting from the use of a non LYNX supplied power source (or adapter) is not covered under warranty

Installation

The MiniModule can be used standalone in any suitable location. The location should be free from any moisture and excessive sources of heat. The ventilation holes in the top and the bottom of the module should be kept un-obstructed at all times or module overheating may occur and result in module damage.

Note. *The module may run warm to the touch, this is normal. The module case is used to shunt heat from some internal components.*

We provide a number of Module mounting options and we recommend the use of these to ensure the module is mechanically secured. These include

R FR 3020 - Individual Mounting Brackets. These may be secured to any surface with mounting screws

RFR 3004 - Wall mounting bracket for 2 MiniModules. This bracket can be secured on the rear or side to any surface and will accommodate two modules. Modules mount using spring clips and can be removed and installed with no tools

RFR 3005 - 19" Rack plate for 5 MiniModules. This rack plate is designed to fit in a standard 19" rack space and is typically installed in the rear of an equipment rack. The plate is hinged to allow access to the rear of the equipment rack. Up to 5 MiniModules can be accommodated. Modules mount using spring clips and can be removed and installed with no tools. This can be used in combination with the **RFR 3010** Central power supply and control chassis to provide centralized power (with optional redundant power protection) as well as accommodation for a rack controller for connection into the LYNX centralized control system.

Please refer to the LYNX catalog or the website www.lynx-technik.com for more information on these options.

Switch Settings

The module has integral dip switches which permit the presetting of basic functions of the C DX 3610 MiniModule.

NOTE

**All changes to switch settings must be made with the power applied.
New settings will not be recognized when the module is powered up if
the settings are changed with power removed.**

The optional control system and RCT 3002 Service Adapter will override any local switch settings so the switches are active in nature. When making local dip switch changes It is necessary to set dip switch 1 into the "Enable Local Adjustments" position = ON with the power applied so the internal CPU can read the new switch settings into flash ram.

The diagram below shows the internal switches and the locations. Please refer to the table for switch functions.

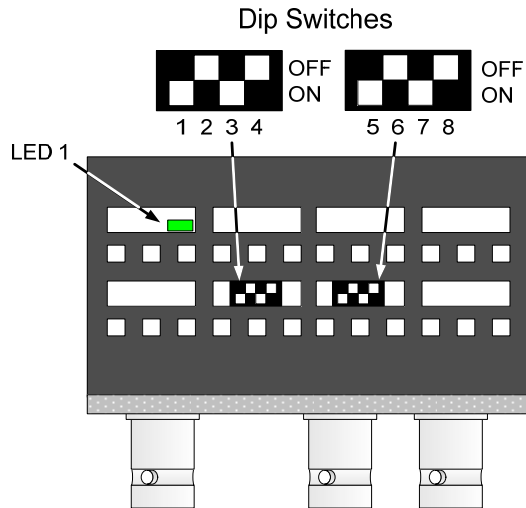

Note. Remember to set switch 1 = ON “Enable Local Adjustments” before making changes. When the settings are changed the CPU will immediately update the modules settings. Moving Switch 1 back into the OFF position will prevent and accidental changes of the switch settings taking effect.

If changes are made with the power not applied leave switch 1 =ON until the module is powered up so the CPU can read the new settings

Dip Switches

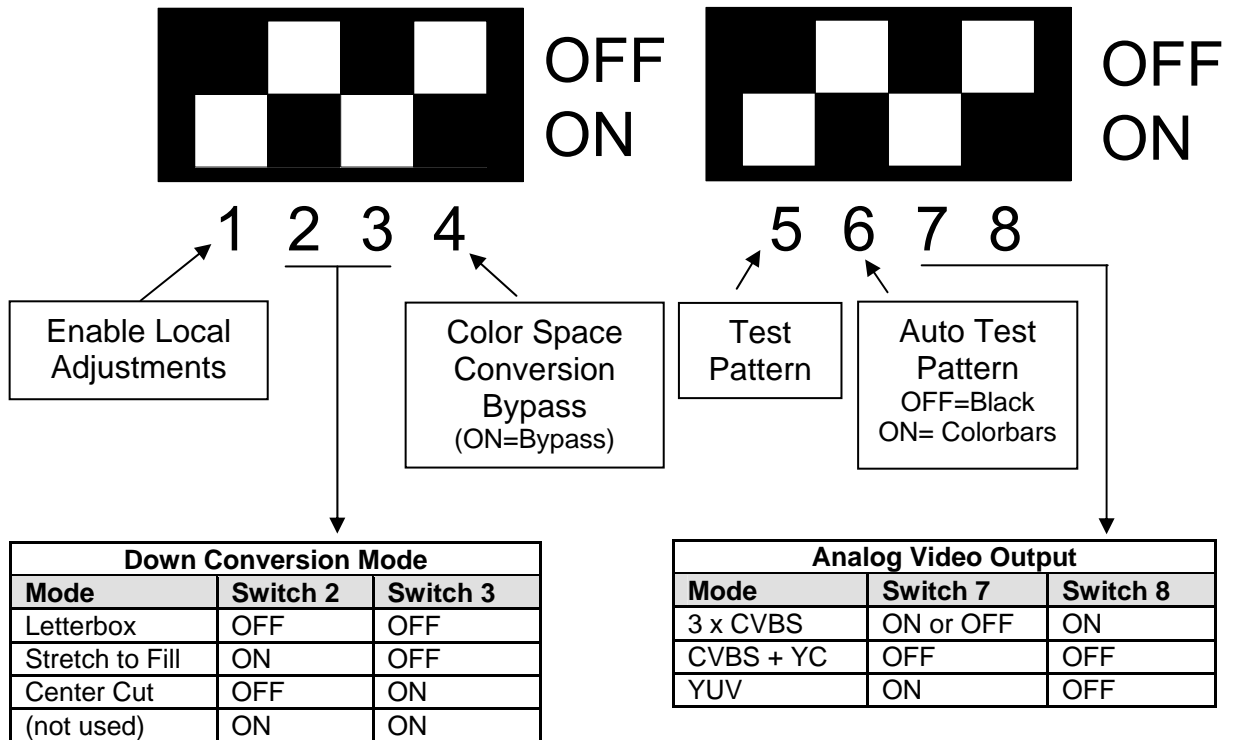

Switch Functions

Switch 1

Enable Local Adjustments – This switch has to be set to ON when changes to the local settings are made using the dip switches. Set to OFF when settings have been made.

Switch 2 / 3

Down Conversion Mode – The combination of these 2 switch settings determines the aspect ratio reproduction mode of the down converter

Switch 4

Color Space Conversion Bypass – Setting this switch to OFF will convert the HDTV 709 color space into SDTV 601 color space. ON will bypass the conversion and the color space used on the input will pass transparently.

Switch 5

Test Pattern - Switches the internal test pattern ON/OFF (default pattern = color bars) and applies pattern to all converted outputs.

Switch 6

Auto Test Pattern – This switch will select the test pattern switched to the outputs if the input fails or is removed OFF = Full field Black ON = 75% Colorbars

Switch 7 / 8

Analog Output Selection – The combination of these two switch settings determines the analog output configuration.

Factory Default Settings

The module is shipped with the following settings programmed. If these are the settings you require then no changes to the switch settings are required

Switch 1 = OFF	(Disable local adjustments)
Switch 2 = OFF	
Switch 3 = ON	(Center Cut Conversion mode)
Switch 4 = OFF	(Color Space Conversion ON)
Switch 5 = OFF	(Test Pattern OFF)
Switch 6 = ON	(Auto Test Pattern = Colorbars)
Switch 7 = ON	
Switch 8 = ON	(3 x CVBS analog Output)

Note. Switching the two digital outputs to be re-clocked versions of the input signal is a mode supported only via the control system or via the RCT 3002 Service Adapter. The Default setting provides two converted digital SDI outputs.

Indicators

Alarm indicator

An Alarm indicator is provided on the front of the module (refer to module layout diagram) this LED has three states. Alarm conditions shown below.

LED Color	Status
Green	Video Present PLL Locked
Yellow	Test Pattern Selected
Red	No Signal and/or PLL unlocked

Module LED

One status LED is visible through the top of the module case (LED1 – refer to module layout diagram). Conditions shown below

LED Color	Status
Green	Input SDI Present
Red	Input SDI missing

GUI Operation

All LYNX MiniModules support a computer interface which allows setting the modules parameters using a simple GUI interface. Access to all standard features and some extended features is possible using this interface.

Access to the GUI requires the use of the optional LYNX central control system of via the optional RCT 3002 USB Service Adapter and desktop controller software (one Service Adapter will support all LYNX MiniModules using a simple Plug and Play interface)

Note. Any settings made using the control system or Service Adapter overrides any local switch settings on the module. All settings are stored in internal flash ram and will survive power cycles and long term storage.

The GUI screenshots below show the settings and adjustments possible for the C DX 3610 MiniModule.

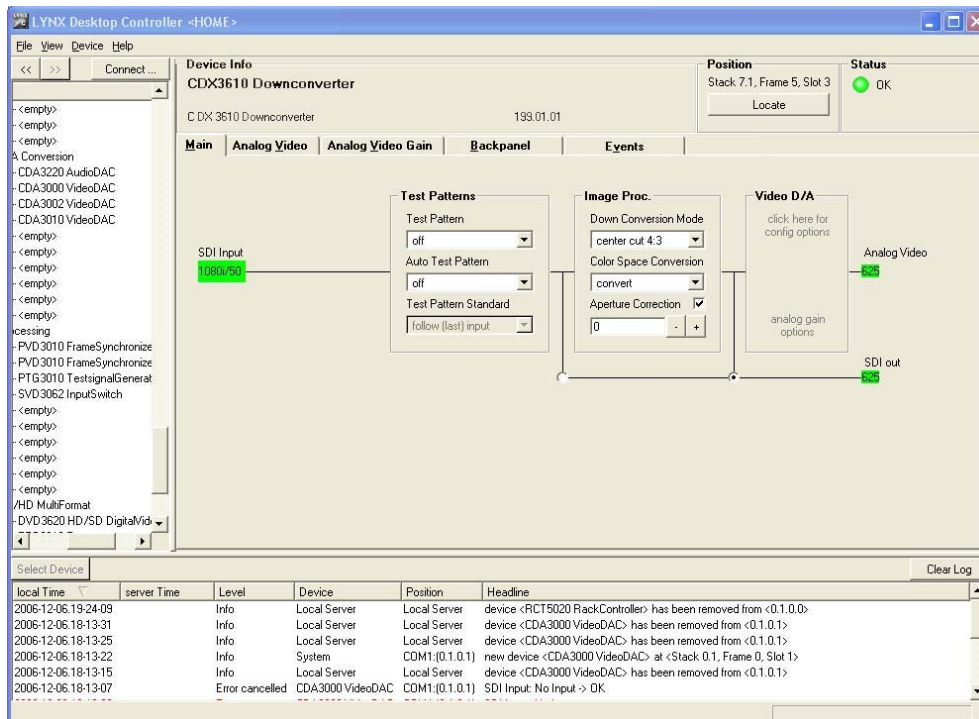

The above screenshot shown the complete module GUI. The Device info area contains information about the module including name and firmware revision. If used as part of a larger system using the LYNX central control system the modules position and physical location is displayed above the "locate" button.

Note. The Locate function is a tool used to quickly identify a module in larger systems. Selecting “locate” will flash the module alarm LED yellow. (Does not effect module operation)

The area at the bottom of the screen is the error log. Any fault condition will be timestamps and entered into the log (as long as the controller / adapter is connected)

There are a number of Tabs associated with each Module which splits up the modules settings into a number of separate screens. The main GUI screens and functions are described below.

Note. If using the RCT 3002 USB Service Adapter the settings will be written to flash RAM automatically after 10 seconds with no activity on the GUI. This can be observed by the alarm LED flashing yellow three times. We recommend you “RELEASE” the module from the GUI before unplugging. This will write all the settings to flash RAM and prepare the module for unplugging. (This also applied to modules used in the central control system)

Main Tab

This screen is the main GUI interface and is presented first when the module is displayed in the GUI. The layout replicates function and the signal flow if from left to right. Selections are made using onscreen sliders, radio buttons, drop down selections and checkboxes.

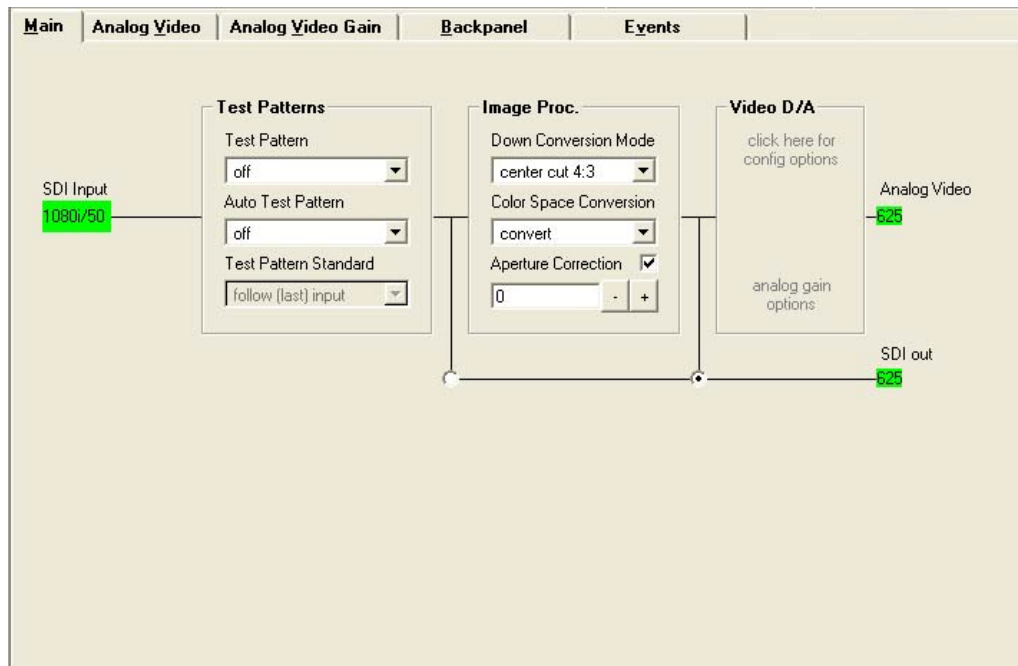

Input Detection

On the left the SDI input is detected and the format displayed on screen.

Test Pattern

This is where the internal test pattern can be switched on via the drop down selections. This will override any input signal. Selections provided are:

- OFF
- Color bars
- Color Bars over Red
- Full field Black
- Pathological PLL/EQ
- Blue Screen

Auto Test Pattern

When the input signal is lost you can configure the module to automatically switch in a test pattern. Selections provided are.

- OFF
- Color bars
- Color Bars over Red
- Full field Black
- Pathological PLL/EQ
- Blue Screen

Test Pattern Standard

Using this drop down selection it's possible to configure the standard of the internal test signal. This can be preset to follow the last input standard connected or forced into any independent standard which is useful if using the module as a test pattern source. Possible standard selections are:

- Follow Last Input
- 525 / 59.94Hz
- 625 / 50 Hz
- 1080i / 59.94Hz
- 1080i / 60Hz
- 1080i / 50Hz
- 720P / 59.94Hz
- 720P / 60Hz
- 720P / 59.94Hz

Down Converter Mode

This drop down selection defines the aspect ratio reproduction for the converted outputs. Selections are

- Center Cut 4:3
- Letterbox
- Stretch to Fill

Color Space Conversion

This drop down selection configures the color space converter. There are three possible settings

- Bypass (Passes the color space on the input)
- Convert (Performs a 709>601 color space conversion)
- Luma in bypass (Only converts the Chroma portion of the signal)

Aperture Correction

We provide a horizontal aperture corrector for the converted outputs which permits the sharpening or softening of the SDTV outputs (a slight roll off in high frequency is a normal part of the down conversion filtering process). The checkbox can be used to switch aperture ON and OFF. (ON= Default). When set to ON a small preset amount of correction is applied to produce a flat frequency response on the outputs. When set to OFF all Aperture correction is removed.

The amount of aperture correction is adjustable (from the factory preset) range: 30....+80. Adjustments in the positive direction will sharpen the image and the negative direction will soften the image.

SDI output routing

There are two small radio buttons which can be used to change the SDI digital outputs. One selection takes the signal before the down converter and will provide two re-clocked outputs of the incoming SDI signal. The other selection (default) provides two converted digital outputs.

Output Standard

The output standard is indicated in green for the analog and digital outputs.

Note

The down converter will automatically select the correct output standard depending on the connected input standard. For example if a 50Hz input signal is detected then a 625 PAL output will be provided. Likewise if a 59.94Hz or 60Hz input is detected then a NTSC 59.94Hz output will be provided.

Analog Video Tab

Main	Analog Video	Analog Video Gain	Backpanel	Events
Output Format				
Output Format		CVBS		
NTSC format options				
add Pedestal		<input type="checkbox"/>		
Pal M		<input type="checkbox"/>		
PAL format options				
Pal N		<input type="checkbox"/>		
Output Filter				
Luminance		Low Pass		
Chrominance		0.65 MHz (LP)		
Output Options				
Blank VBI		<input type="checkbox"/>		
Chrominance off		<input checked="" type="checkbox"/>		
Burst off		<input type="checkbox"/>		
Line Duration		CCIR 601		
Special Functions				
Luma Delay		222 ns		
Chroma Delay		148 ns		
Double Buffering		<input type="checkbox"/>		

This GUI screen is where you would access all the controls for the video analog to digital conversion.

Output Format

Use this drop down selection to configure the analog outputs. Selections are

- 3 x CVBS
- 1 x CVBS + YC
- YUV

The “Add Pedestal” function is enabled when a NTSC is being provided and checking this box will add a 7.5IRE Pedestal to the analog outputs.

NTSC Output Options

There are two check boxes provided which are for configuration of the video signal when in NTSC (525) output mode.

Add pedestal (when selected) will add a 7.5IRE pedestal to the analog outputs.

PAL M will configure the NTSC outputs to the PAL M standard.

PAL Output Options

There is one selection possible when in PAL (625) mode. When selected this will format the outputs into the PAL N video standard.

Luminance Filter

This drop down selection allows the selection of the Luminance filtering characteristics for the analog to digital converter. Settings are listed below followed by the filter response characteristics.

- Extended Mode (default)
- Notch Filter
- Lowpass
- CIF

Extended Mode (Default)

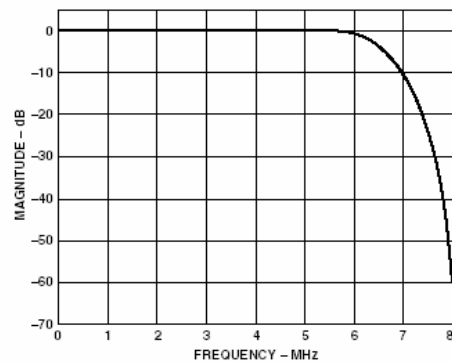

Notch Filter (PAL)

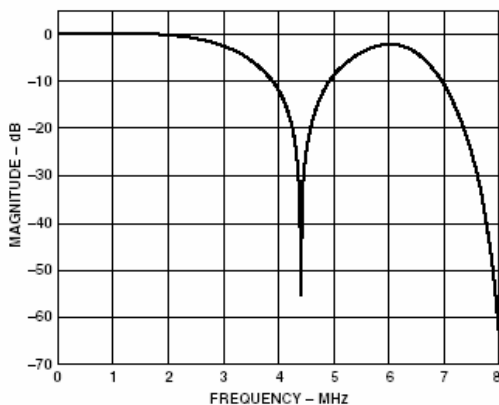

Low Pass (PAL)

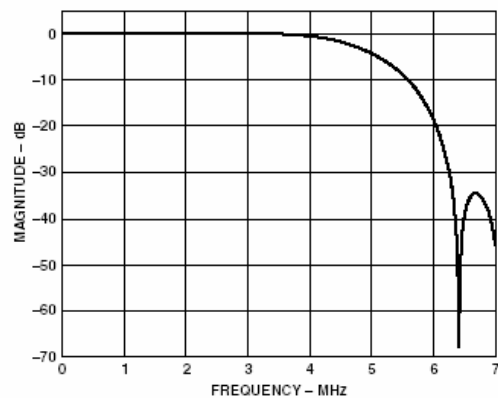

CIF (PAL)

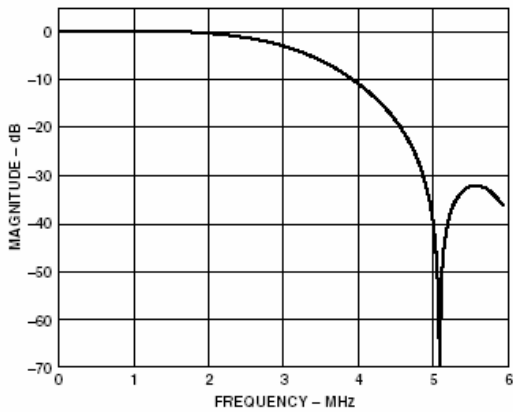

Chrominance Filter

It's also possible to configure the filter response for the chrominance portion of the signal. The drop down box provides the following selections and the filter characteristics are shown for each.

- 3.0 MHz (default)
- 0.65 MHz
- 1 MHz
- 1.3 MHz
- 2 MHz
- CIF
- QCIF

3.0 MHz (Default)

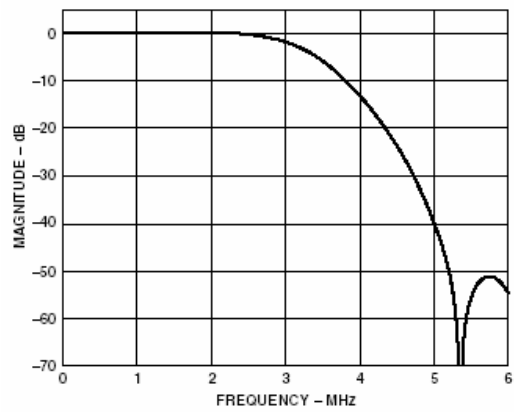

0.65 MHz

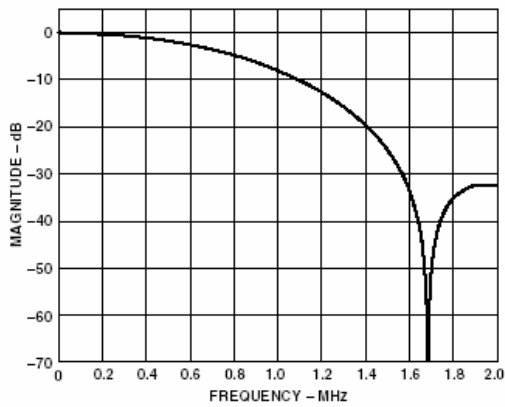

1.0 MHz

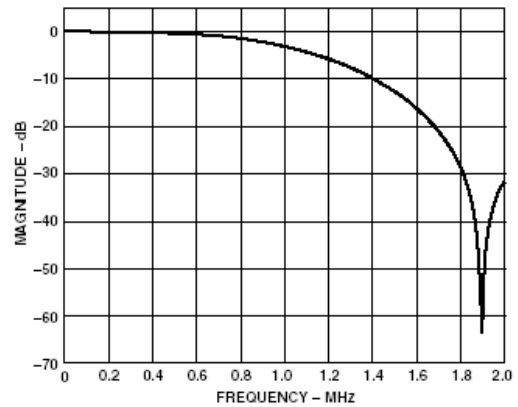

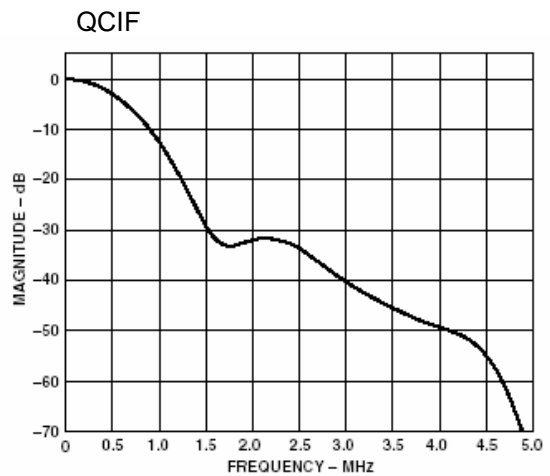
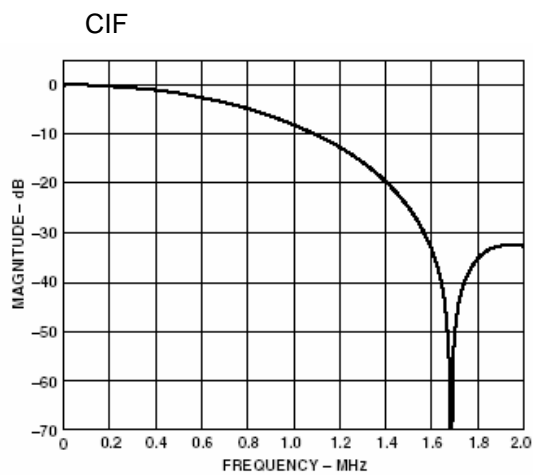
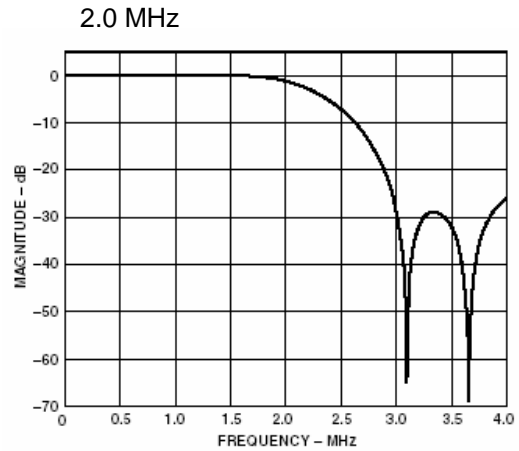
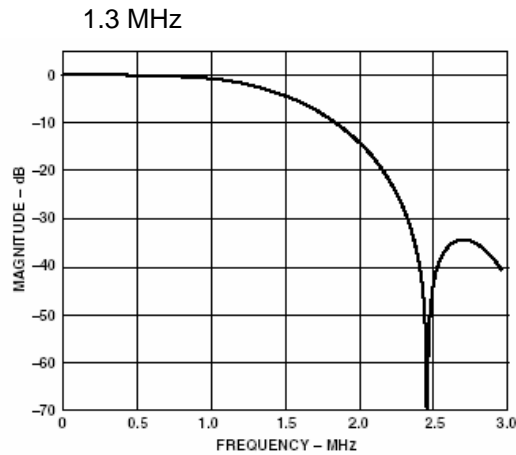

Output Options

Blank VBI – When selected this will completely blank any information in the vertical interval. Left unchecked the module will pass any VBI information transparently.

Chrominance off – When selected this will turn off the chrominance part of the signal and a luminance only (black and white) image will be provided.

Burst off – When in composite mode this will remove the burst portion of the composite signal from the composite outputs.

Active Line Duration

The active line length can be switched between analog and digital blanking. Selections provided are:

- ITU-B 470 (702 pixels active) = analog blanking
- CCIR 601 (720 pixels active) = digital blanking

Special Functions

These functions are for specialized use only and should be left set to the factory defaults unless you are sure you need to adjust these parameters.

Luminance Delay – This allows for the delay of the Luminance signal relative to sync (and Chroma) by the time period specified (default 0)

Chrominance Delay – This allows for the delay of the Chrominance signal relative to sync (and Luma) by the time period specified (default 0)

Double Buffering – This is double buffers the video signal so that any changes made to the module settings over the remote Ic2 interface occurs in the vertical blanking interval.

Analog Video Gain Tab

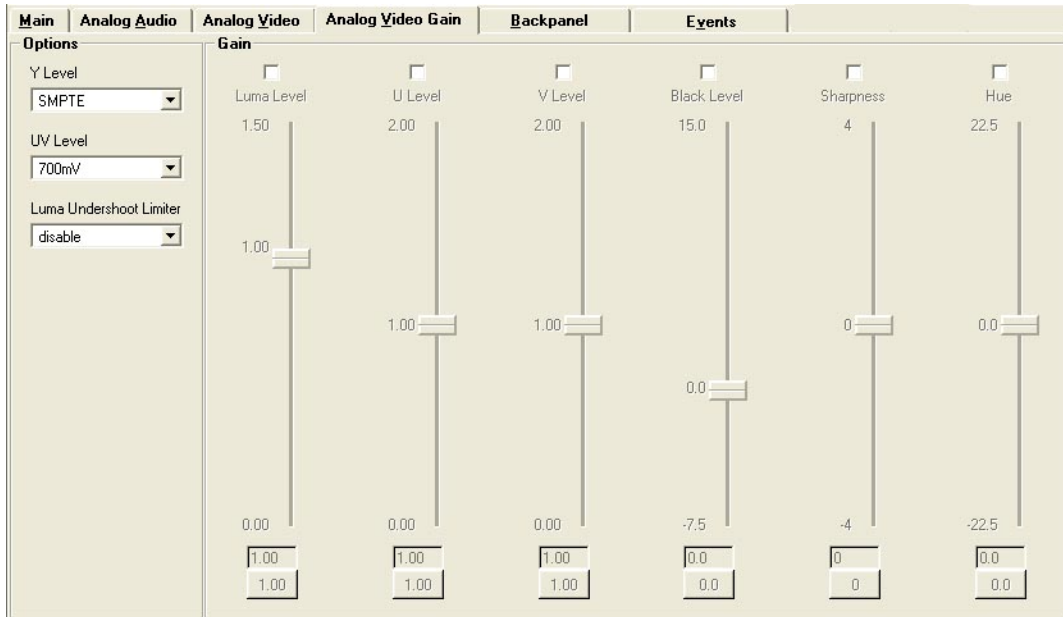

This GUI screen provides access to the internal video processing amplifier where gain levels can be adjusted and set. Default is a null setting for all adjustments.

Note. The buttons at the bottom of each slider will return the settings to the factory preset null setting.

Options

Y level – The Y level can be changed, which depends on the application. Possible settings are:

- SMPTE (default)
- BETACAM

UV Level – The UV levels used can be preset which depends on the application. Possible settings are

- 700mv
- 1000mv
- 648mv

Luminance Undershoot Limiter

With this selection is possible to limit the undershoot of the luminance portion of the signal. The following limits are possible selected by the drop down box:

- Disable (default)
- -1.5 IRE
- -6.0 IRE
- -11 IRE

Video Adjustments

A bank of six on screen sliders is provided for the adjustment of various video parameters. These settings apply only for the analog video outputs. Settings provided are:

- Luma Level
- U Level
- V Level
- Black Level
- Sharpness
- Hue

To operate a slider it must be enabled by selecting the check box above, dragging the slider will change the desired level. To return a slider to the factory default (null) setting click the button below the slider.

Note. Sharpness is a different adjustment to the Horizontal Aperture Correction provided earlier in the processing chain.

Note. If using the RCT 3002 USB Service Adapter the settings will be written to flash RAM automatically after 10 seconds with no activity on the GUI. This can be observed by the alarm LED flashing yellow three times. We recommend you "RELEASE" the module from the GUI before unplugging. This will write all the settings to flash RAM and prepare the module for unplugging.

This can be done by selecting the "**Device>Release**" from the drop down menus

Specifications

Video Input	
Signal Type	Serial Digital Video (SDI) SMPTE 292M, 344M, 259M with automatic input standard detection
Supported Formats	525/59.94Hz 625/50Hz 1080i/59.94Hz/60Hz/50Hz 720P/59.94Hz/60Hz/50Hz
Input Impedance	75 Ohms
Input Level	0.8v
Connector	BNC
Return Loss	>15dB (270Mbits) >10dB (1.485Gbits)
Digital Video Outputs	
Signal	2 x Serial Digital Video (SDI) SMPTE 292M, 344M, 259M
Output Impedance	75 Ohms
Output Level	0.8v pp +/- 10%
Return Loss	> 15dB (1.5 Ghz)
Connection	BNC
Jitter	<0.20 UI (270 Mbits) <0.25 UI (1.485Gbits)
Analog Video Outputs	
Modes	3 x CVBS or 1 x CVBS + YC or YUV
TV Standard	NTSC and PAL (auto detect) PAL M and PAL N (selected via service adapter or control system)
Return Loss	>35 dB (5.75MHz)
Signal to Noise	> 60 dB
D/A Conversion	10 bits and 54 MHz (4x over sampling)
Electrical	
Operating Voltage	+ 5 VDC
Connector	Lemo 5 pin locking connector
Power Consumption	8 W
Safety	IEC 950 / EN 60950 / VDE 0805
Mechanical	
Size	85.5mm x 71mm x 41.5mm + connections
Weight	320g
Ambient	
Temperature	5°C – 35°C Maintaining Specifications
Humidity	80% non condensing

Service

Parts list

There are no user serviceable parts for the MiniModule. Please refer to the service section of this manual for details on how to obtain repairs.

Note

**Do not remove the covers or otherwise disassemble the MiniModule.
This will void Warranty**

Technical Support

If you are experiencing problems, or have questions please contact your local distributor for further assistance.

Technical support is also available from the LYNX website.

Please do not attempt to return products directly to LYNX without an RMA. Please contact your authorized dealer or reseller for details.

More detailed product information and product updates may be available on our web site:

www.lynx-technik.com

Contact information

Please contact your local distributor; this is your local and fastest method for obtaining support and additional sales information.

LYNX Technik can be contacted directly using the information below.

Address LYNX Technik AG
Brunnenweg 3
D-64331 Weiterstadt
Germany.

Website www.lynx-technik.com

E-Mail info@lynx-technik.com

LYNX Technik manufactures a complete range of high quality modular products for broadcast and Professional markets, please contact your local representative or visit our web site for more product information.

