



Version 1.2

Reference Manual

C AD 5121

CVBS to SDI Converter & Line Synchronizer

Series 5000
CardModule

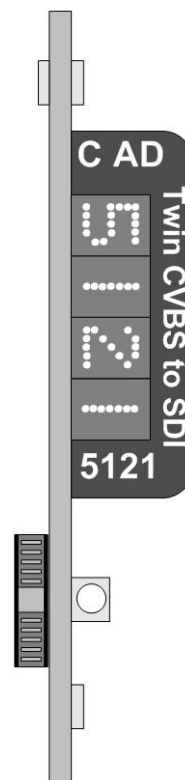
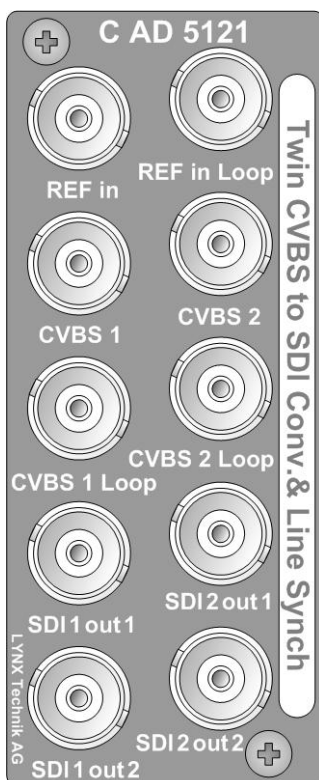

© LYNX Technik AG
Brunnenweg 3
D-64331 Weiterstadt
Germany
www.lynx-technik.com

Information in this document is subject to change without notice. No part of this document may be reproduced or transmitted in any form or by any means, electronic or mechanical for any purpose, without express written permission of LYNX Technik AG.

LYNX Technik AG may have patents, patent applications, trademarks, copyrights or other intellectual property rights covering the subject matter in this document. Except as expressly written by LYNX Technik AG, the furnishing of this document does not give you any license to patents, trademarks, copyrights or other intellectual property of LYNX Technik AG or any of its affiliates.

© LYNX Technik AG 2004 -2007 all rights reserved

Warranty

LYNX Technik AG warrants that the product will be free from defects in materials and workmanship for a period of two (2) years from the date of shipment. If this product proves defective during the warranty period, LYNX Technik AG at its option will either repair the defective product without charge for parts and labor, or will provide a replacement in exchange for the defective product.

In order to obtain service under this warranty, customer must notify LYNX Technik of the defect before expiration of the warranty period and make suitable arrangements for the performance of service. Customer shall be responsible for packaging and shipping the defective product to the service center designated by LYNX Technik, with shipping charges prepaid. LYNX Technik shall pay for the return of the product to the customer if the shipment is within the country which the LYNX Technik service center is located. Customer shall be responsible for payment of all shipping charges, duties, taxes and any other charges for products returned to any other locations.

This warranty shall not apply to any defect, failure, or damage caused by improper use or improper or inadequate maintenance and care. LYNX Technik shall not be obligated to furnish service under this warranty a) to repair damage resulting from attempts by personnel other than LYNX Technik representatives to install, repair or service the product; b) to repair damage resulting from improper use or connection to incompatible equipment; c) to repair any damage or malfunction caused by the use of non LYNX Technik supplies; or d) to service a product which has been modified or integrated with other products when the effect of such modification or integration increases the time or difficulty servicing the product.

THIS WARRANTY IS GIVEN BY LYNX TECHNIK WITH RESPECT TO THIS PRODUCT IN LIEU OF ANY OTHER WARRANTIES, EXPRESS OR IMPLIED. LYNX TECHNIK AND ITS VENDORS DISCLAIM ANY IMPLIED WARRANTIES OF MERCHANTABILITY OR FITNESS FOR A PARTICULAR PURPOSE. LYNX TECHNIK`S RESPONSIBILITY TO REPAIR AND REPLACE DEFECTIVE PRODUCTS IS THE SOLE AND EXCLUSIVE REMEDY PROVIDED TO THE CUSTOMER FOR BREACH OF THIS WARRANTY. LYNX TECHNIK AND ITS VENDORS WILL NOT BE LIABLE FOR ANY INDIRECT, SPECIAL, INCIDENTAL, OR CONSEQUENTIAL DAMAGES IRRESPECTIVE OF WHETHER LYNX TECHNIK OR THE VENDOR HAS ADVANCE NOTICE OF THE POSSIBILITY OF SUCH DAMAGES.

Regulatory information

Europe

Declaration of Conformity

We	LYNX Technik AG Brunnenweg 3 D-64331 Weiterstadt Germany
<i>Declare under our sole responsibility that the product</i>	
TYPE: C AD 5121	
<i>To which this declaration relates is in conformity with the following standards (usage in environment E1 – E3):</i>	
EN 55103-1 /1996	
EN 55103-2 /1996	
EN 60950 /2001	
<i>Following the provisions of 89/336/EEC and 73/23/EEC directives.</i>	
	Winfried Deckelmann
Weiterstadt, December 2004	
<i>Place and date of issue</i>	<i>Legal Signature</i>

USA

FCC 47 Part 15

This device complies with part 15 of the FCC Rules. Operation is subject to the following two conditions: (1) This device may not cause harmful interference, and (2) this device must accept any interference received, including interference that may cause undesired operation.

Note: This equipment has been tested and found to comply with the limits for a Class A digital device, pursuant to the part 15 of the FCC Rules. These limits are designed to provide reasonable protection against harmful interference when the equipment is operated in a commercial environment. This equipment generates, uses, and can radiate radio frequency energy and, if not installed and used in accordance with the instruction manual, may cause harmful interference to radio communications. Operation of this equipment in a residential area is likely to cause harmful interference in which case the user will be required to correct the interference at his own expense

Contents

Warranty	3
Regulatory information	4
Europe	4
Declaration of Conformity	4
USA.....	4
FCC 47 Part 15	4
Contents	5
Getting Started	7
Packaging	7
Product Description.....	7
Functional Diagram.....	8
Module Layout.....	8
Connections	10
Video Connections	10
Installation	11
Settings and Control	12
Multi Function Switch.....	13
Using the Local Display Menus.....	14
Navigation.....	14
Local Adjustments Available.....	14
Menu Structure.....	15
Factory Preset Condition	22
Auto Store.....	23
Test signal output if no input	23
Alarm/LED Status Indicators	24
Status Indicators.....	24
Alarm Indicator.....	24
Locate Function	25
Specifications (C AD 5121)	26
Available Options	27
Parts List	27
Service	28
Contact Information	29

This page is intentionally left blank

Getting Started

Packaging

The shipping carton and packaging materials provide protection for the module during transit. Please retain the shipping cartons in case subsequent shipping of the product becomes necessary.

Product Description

The C AD 5121 is a high performance twin 12 Bit Video A/D Converter for analog PAL/NTSC composite signals and is designed primarily for broadcast and professional applications.

Two loop-through input signals are converted independently, the inputs can be selected per channel. The input architecture is differential to assure optimal resistance against distortion. Automatic Gain Control is integrated into the input stage. PAL/ NTSC Input detection is automatic. Either an external loop-through reference or the internal rack reference (black burst signal) can be used to line-synchronize the SDI outputs.

The C AD 5121 features a wide range of available adjustments (via optional Rack Controller). Basic adjustments are possible using via the local multi-function switch and integrated display.

CardModules are installed in the series 5000 card frame that can accommodate up to 10 CardModules. All modules are hot swappable and Options include full redundant power and a range of controller options.

Functional Diagram

Figure 1 below is the basic functional diagram for the C AD 5121 CardModule.

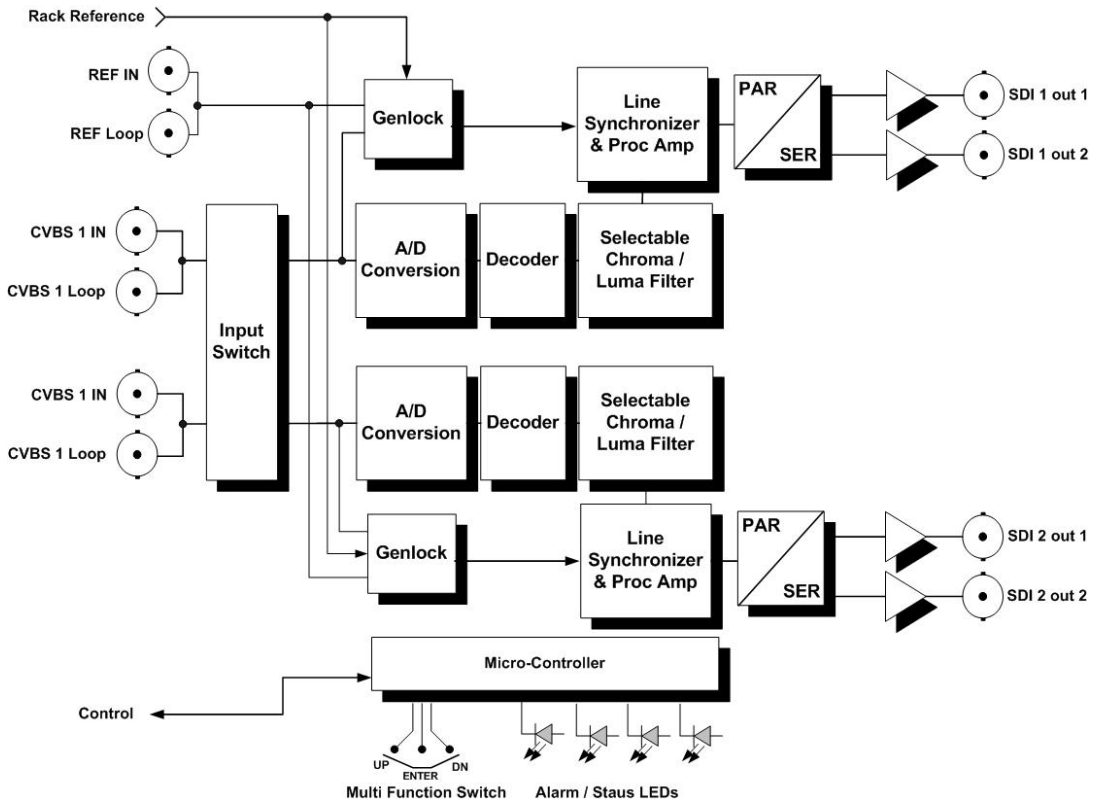

Figure 1- C AD 5121 Functional Diagram

Module Layout

Figure 2 shows the physical layout of the C AD 5121 CardModule and also the connection panel which is fitted to the rear of the rack.

PCB Layout



Rear Connection Panel

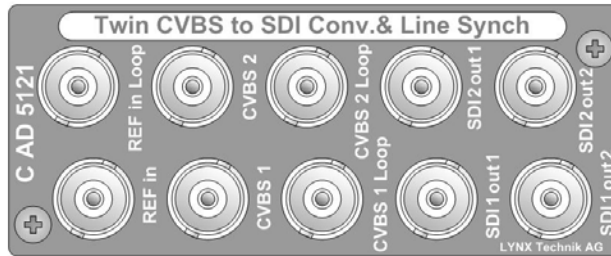

PCB Front View

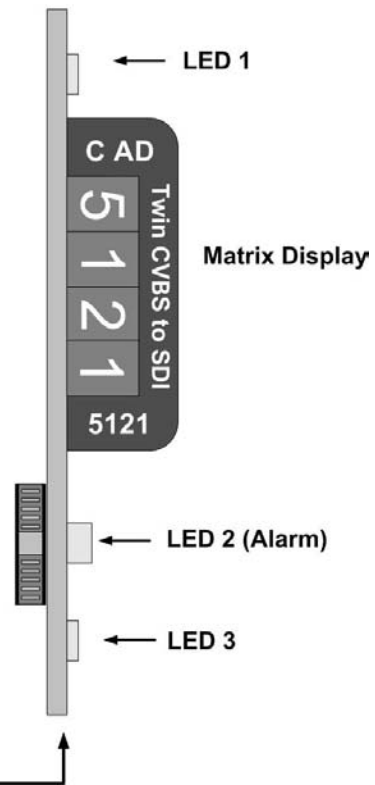

Figure 2 – Module Layout



Caution

Use static precautions when handling the PCB. Static discharge could result in serious damage to the module.

Connections

Video Connections

The C AD 5121 CardModule is configured with standard 75 Ohm BNC connectors. Connection is self-explanatory. We recommend the use of high quality video cable for digital video connections to reduce the risk of interference or errors due to excessive cable attenuation. Some guidelines for max cable length are shown below.

250m (820 feet) Belden 8281 (270Mbits/s)

Note. Due to the compact design of the connection plate it will be necessary to use a connection tool to secure the BNC video connectors.

Installation



Caution

The CardModule is shipped in a protective anti-static bag. Please take suitable precautions to avoid static discharge onto any part of the PCB or components when handling module or serious damage could result.

Each Card Module is supplied with a rear connection panel and two mounting screws. Please follow the following procedure for installation of the card module into the Series 5000 Card Frame.

- a) Select a slot in the card frame where the CardModule will be located
- b) Remove the blank connection panel from the rear of the rack (if fitted)
- c) Install the rear connection panel using the screws supplied. Do not tighten the screws fully
- d) Slide the card module into the card frame and carefully check the CardModule easily connects to the rear connection plate. The card should fit easily and should not require excessive force to insert, if you feel any resistance, there could be something wrong with the rear connection panel location. Do not try and force the connection. Remove the rear connection panel and check alignment with the CardModule.
- e) Insert and remove the CardModule a few times to ensure correct alignment and then tighten the two screws to secure the rear connection plate

Settings and Control

The C AD 5121 has an integrated micro-controller, which enables the module to be configured and controlled locally using the multifunction switch and 4 character dot matrix display, or from remote when using one of the optional controllers and control software.

Once set, all settings are automatically saved in non-volatile internal memory. (Flash ram) The module will always recall the settings used prior to power down.

PCB Front View

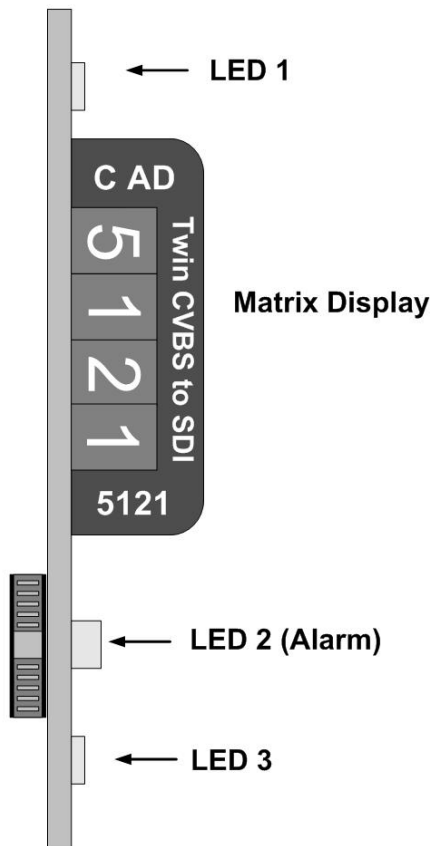
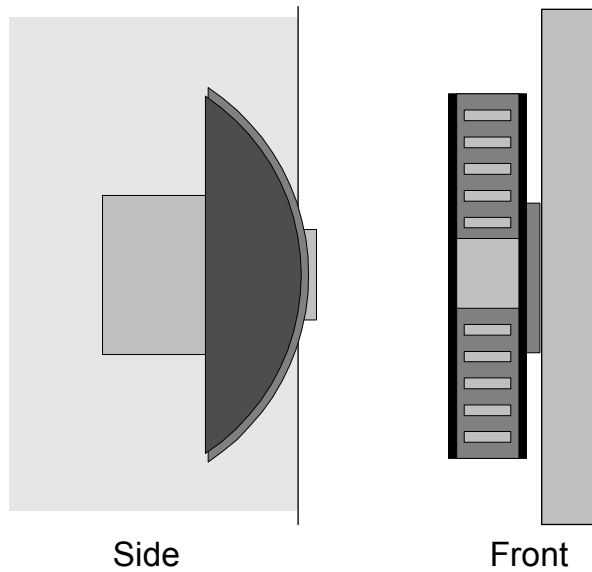

Figure 3 – Switch and Display Location

Multi Function Switch

The CardModule is equipped with a multi-function switch located on the front bottom edge of the card (refer to figure 3)

Multi-function Switch



Switch Operations

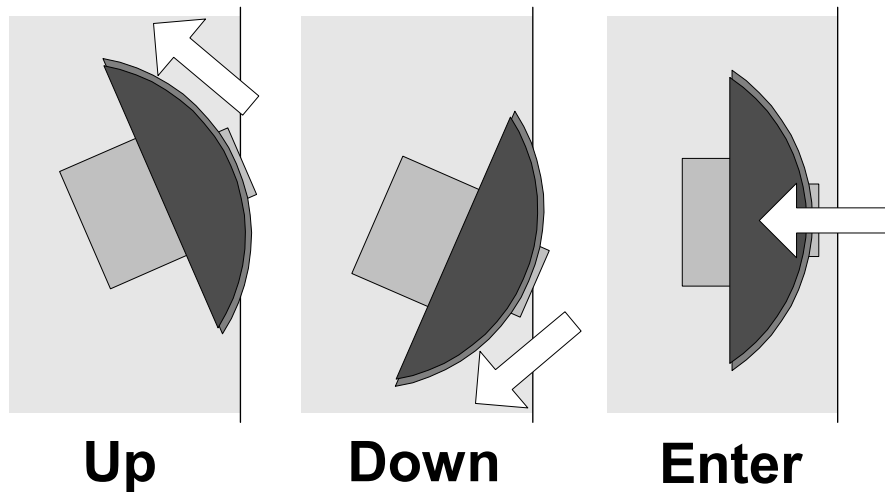

Figure 4 – Switch Operation

Using the Local Display Menus

Making local adjustments to the module is done using the multifunction switch and the integrated 4-character dot matrix display (figure 3). The menu system is layered, and navigation through the system is done using the **UP** and **DOWN** functions of the switch. **ENTER** is used to move between menu levels and also enter a selection.

Navigation

Switch Function	Operation
UP	Move UP within a level
DOWN	Move down within a level
ENTER	Change levels / Make selection

Local Adjustments Available

All of the critical adjustments to the module are accessible using the local display and multi-function switch, these include:

- External / Rack Internal sync reference select
- Analog input filter on/off
- Genlock mode
- Luma-/ chroma filter settings
- Luma/Chroma Comb mode
- Auto-/ manual gain control
- CTI (Color Transition Improvement)
- Digital Noise Reduction (Removal of small Luma details)
- Test signal select

A set of extended adjustments is possible when using a controller option and LYNX control software. Adjustments (in addition to the basic adjustments above) include:

- Adjustable Luma / chroma filters
- Adjustable Coring function
- Adjustable Contrast, Saturation, Brightness and Hue
- Automatic Gain Control mode reference select

Menu Structure

The Menu structure is defined in the next table, and should be used when navigating through the system.

Notes / Tips.

ENTER moves between Levels

UP/DOWN moves between items within the level

When you enter a new setting the system will jump back one level in the menu system.

The “back” selection in the menu structure will take you back one level when selected.

When an item is selected which has several setting possibilities the first value displayed will be the value currently stored in the system. The order of the available settings for any menu item in the table supplied does not represent the order the settings will actually be displayed.

If left unattended, the menu will default to the root display after a preset timeout.

ROOT	Level 1	LEVEL 2	LEVEL 3	LEVEL 4	LEVEL 5	COMMENTS
5121	CH1 CH2	IN	SIG	IN 1 IN 2 back		"Normal" Root display on module = Module type
			FILT	OFF EN 1 FLAT back		Input signal select: Free selection of input per channel
			STD	PAL	Pcnp Pcn Pmp Pm Pnp Pb back	Analog filter selection
				NTSC	Nm Nmp N4 N4p back	PAL (BGHID) PAL (N) with Pedestal PAL (M) PAL (M) with Pedestal PAL combination (N) PAL combination (N) with Pedestal

	<p>GENL</p>	<p>VID</p>	<p>AUTO</p> <p>back</p>	<p>PbN</p> <p>PbNP</p> <p>PnN</p> <p>PhNP</p> <p>back</p>	<p>Auto Detect: PAL (BGHID) and NTSC(M) Auto Detect: PAL (BGHID) and NTSC(M) with Ped Auto Detect: PAL (N) and NTSC(M) Auto Detect: PAL (N) and NTSC(M) with Ped</p>
	<p>LO Q</p> <p>HI Q</p> <p>back</p>	<p>LO Q = "Video Tracking Mode" for inputs with poor signal quality HI Q = VCXO mode, for inputs with high quality signals</p>			

									EXT = set reference to external input INT = set reference to rack reference OFF = set reference to video input with minimum delay
									Enter line delay in no. of lines Enter pixel delay 0 1715 for NTSC 01727 for PAL automatic wrap to next line when limit reached
									Active, if Comb Filters switched off Select luminance filter: NN1: Narrow Notch 1 NN2: Narrow Notch 2 NN3: Narrow Notch 3 WN1: Wide Notch 1 WN2: Wide Notch 2
									Active, if Comb Filters switched on Select lowpass filter: 1 (= 0.5 MHz) ...18 (= 5.5 MHz)
									Select chroma bandwidth (in MHz)

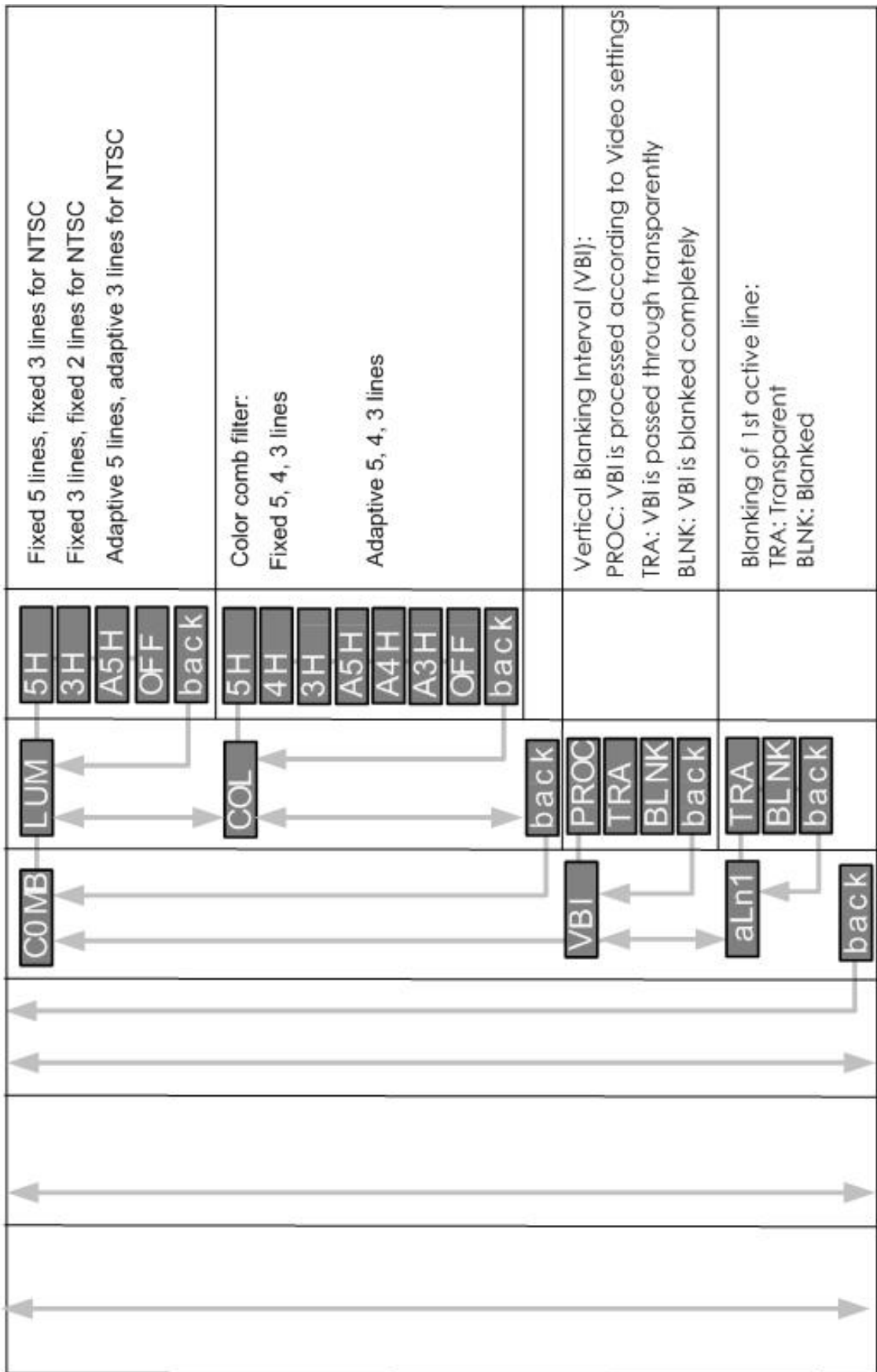

	AGC	LUM	AUTO MAN back	0000	Set luminance gain: AUTO = based on sync tip amplitude MAN = Enter required gain value
		COL	AUTO MAN back	0000	Set Chroma gain: AUTO = based on color burst amplitude MAN = Enter required gain value
		back			
	HUE	0000			Hue: Enter required value (0..127; Factory Preset: 0)
	CRMA	0000			Chroma Gain (Saturation): Enter required value (0..255; Factory Preset: 128)
	PED	0000			Luma Pedestal (Brightness): Enter required value (-128..127; Factory Preset: 0)
	GAIN	0000			Luma Gain (Contrast): Enter required value (0..255; Factory Preset: 128)
	CTI	OFF 0000 back			Color Transition Improvement: Level 1..4
	DNR	OFF LOW HIGH back			Digital Noise Reduction

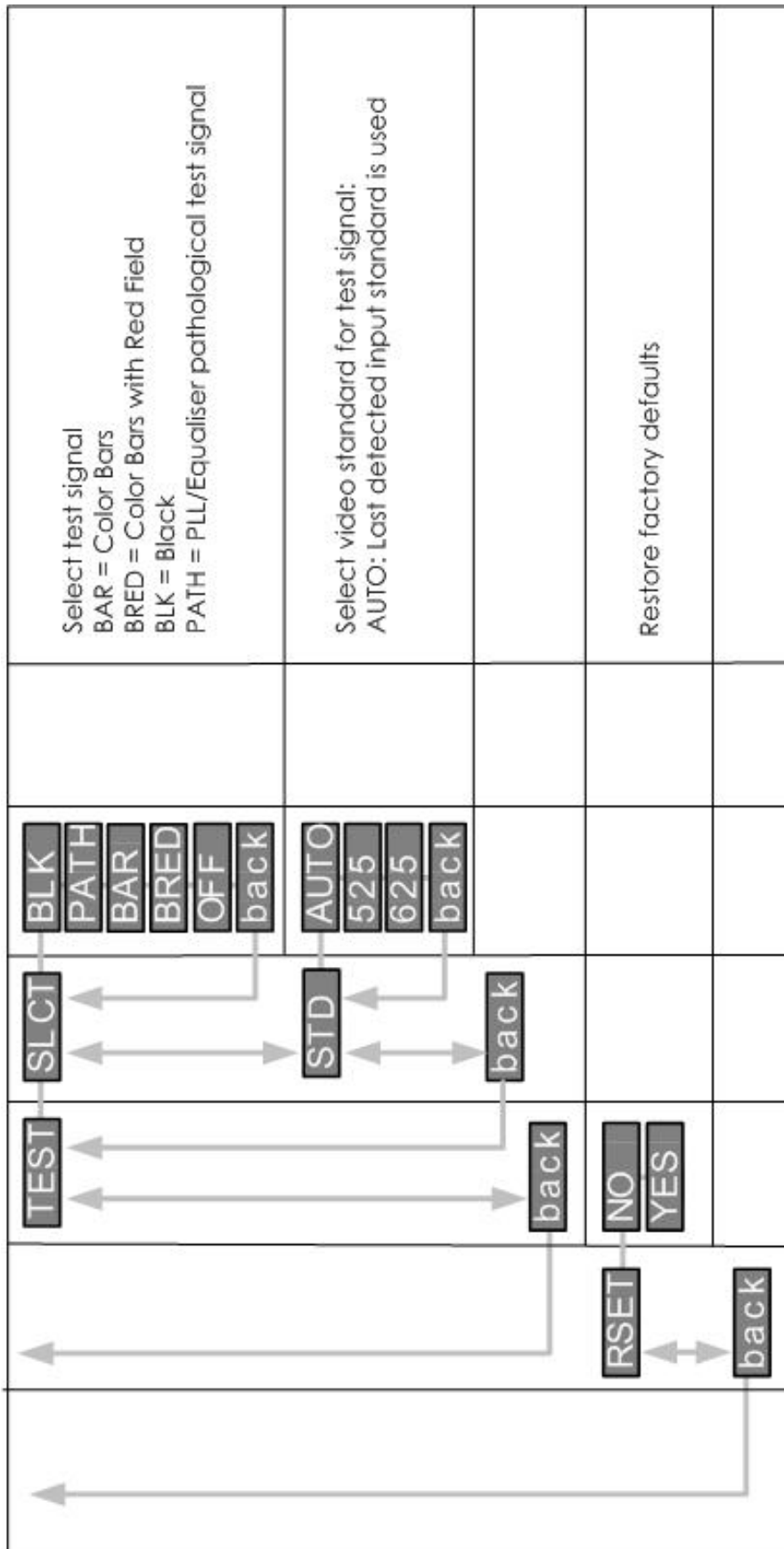

Factory Preset Condition

The C DA 5121 is delivered programmed and preset for the following mode of operation:

Input Select:

Channel 1	Input 1
Channel 2	input 2
Analog Filter	OFF
Standard	PAL Pb (BGHID) or NTSC (auto detect)
Genlock	HI Q
Reference	Internal (Rack Reference)
Line delay	0000
Pixel delay	0000
Lum filter	LP 18 (5,5 MHz)
Chroma filter	1.5 MHz
Chroma Comb filter	PAL: adaptive 4 H NTSC: adaptive 3H
Luma Comb filter	PAL: adaptive 4 H NTSC adaptive 3H
VBI	TRA
CTI	OFF
DNR	LOW
AGC Lum	Auto
AGC Col	Auto
Hue, Pedestal	0
Chroma, Gain	128
Test Signal	OFF
Test Signal Standard	Auto

If this is the mode of operation required, then no adjustments are necessary.

These settings can be recalled at any time by selecting reset from the menu system.

Auto Store

If no parameters are changed for 10 seconds then the current settings will be written into flash memory automatically, this can be seen by the alarm LED flashing yellow four times.

Test signal output if no input

The C AD 5121 provides a set of test signals (color bars, colors over red field, black, pathological PLL/EQ) per channel. This can be activated in normal operation.

If no input signal is available a blue screen will be activated on the output. This can be deactivated with the LYNX C3_local SW. Then the last selected test signal will be activated in the output if no input is applied.

Alarm/LED Status Indicators

The C AD 5121 module has integral LED indicators, which serve as alarm and status indication for the module. Function is described below.

Status Indicators

2 status LED`s are provided on the front edge of the module, LED 1, LED 3 (figure 2)

LED	Color	Indication
1	Green	Input 1: Video and Reference present or Video present and REF OFF selected
	Yellow	Input 1: Video present, Reference missing Or Test signal selected
	Red	Input 1: Video and Reference missing
2	Green	Input 2: Video and Reference present or Video present and REF OFF selected
	Yellow	Input 2: Video present, Reference missing Or Test signal selected
	Red	Input 2: Video inputs missing

Alarm Indicator

There is also a single alarm LED on the lower edge of the module LED 2. This is visible through the card frame front cover and provides a general indication of the module status.

LED Color	Indication
Green	Signals and Reference present or Signals present and REF OFF
Yellow	LED1 or LED 2 yellow
Red	No input signals

LED **OFF** indicates power is lost, or there is a power supply fault.

Locate Function

For larger systems which may have multiple cards of the same type in a single rack, or multiple rack systems on a large central control system we have added a useful utility which will help to visually locate a suspect module quickly (When used in conjunction with the optional control system and software)

Once the specific module has been selected on the control system there is a locate button on the top of the GUI:



Locate Function in Control System

When Locate is selected the status indicator on the GUI and the alarm LED will flash yellow in the following continuous sequence.

3 short flashes.... Pause.... 3 short flashes ...

Use of the locate function will not interfere with the normal operation of the module.

For more details on this feature please check the documentation supplied with the controller software.

Specifications (C AD 5121)

Inputs (video)

Signal	NTSC -(M/N), PAL (B/D/G/H/I/M/N), two loop-through inputs. AC coupled, differential inputs
Input Impedance	75 Ohms
Connection	BNC

Inputs (ext reference)

Signal	Composite sync (black burst)
Input Impedance	75 Ohms
Connection	BNC

Outputs

Signal	2 x serial 4:2:2 SMPTE 259M-C (270 Mbps)
Output Level	0.8V p-p
Jitter	< 0.2UI
Return loss	> 15dB
Connection	BNC
Output Impedance	75 Ohms

Operating Modes

CCVS	NTSC/ PAL decoding modes can be adjusted according to the application. See remote adjustable parameters. Parameter settings can be stored in remote operation.
Test	Built in Color Bars, PLL pathological, EQ pathological, black flat field

Performance

Quantization	12 Bits for Luma and Chroma
Frequency Response	$\pm 0,15$ dB ...5,0 MHz, $\pm 0,2$ dB ...5,5 MHz for Luma
Sampling	54 MHz (4 x oversampling)
Filters	Selectable Luma/Chroma comb filters (5 line, adaptive), various Luma / Chroma filters
Processing Delay	Adjustable pixel, line, delay up to 6 lines
S/N Ratio	< -61 dB (unweighted to 5,75 MHz)

Electrical Specifications

Operating Voltage	+ 12 VDC
Power Consumption	8 W
Safety	IEC 60950/ EN 60950/VDE 0805

Mechanical

Size	283mm x 78mm
Weight	Card module 120g, connection panel 50g

Ambient

Temperature	5°C to 40°C Maintaining specifications
Humidity	Max 90% non condensing

Supplied Accessories

Documentation	C AD 5121 Reference Manual
---------------	----------------------------

Available Options

Below is a list of related products for the C AD 5121 CardModule. Please refer to product brochures or our web site for more detailed information.

Model	Description
R FR 5010	Series 5000 Rack Frame (empty) with single power supply
R PS 5010	Redundant power supply for the R FR 5010 Card Frame
R CT 5030	Master controller for the R FR 5010 Card Frame with TCP/IP interface
R CT 5020	Rack controller for the R FR 5010 Card Frame
R CT 5010	Rack Bus Extension for the R FR 5010 Card Frame. In combination with R CT 5020/5030

Parts List

Due to the very dense design and miniature surface mount technology the module is not field serviceable. The information for a replacement assembly is below.

C AD 5121 CardModule (complete)

Description	Twin CVBS to SDI Converter
Model Number	C AD 5121
Part Number	5.155.001.250

Sub Assemblies:

C AD 5121 Processing Board only (BS5028_B)

Part Number	6.155.001.255
-------------	---------------

Rear Connection Panel for C AD 5121 (MA5018)

Part Number	6.155.007.210
-------------	---------------

Service

If you are experiencing problems, or have questions concerning your C AD 5121 CardModule please contact your local distributor for assistance.

We offer a fixed cost service exchange program for defective Series 5000 CardModules out of Warranty. Please contact your distributor or check our web site for details on this program.

More detailed information and product updates may be available on our web site:

www.lynx-technik.com

You will also find links to contact us directly for assistance.

Contact Information

Please contact your local distributor; this is your local and fastest method for obtaining support and sales information.

LYNX Technik can be contacted directly using the information below.

Address LYNX Technik AG
Brunnenweg 3
D-64331 Weiterstadt
Germany.

Website www.lynx-technik.com

E-Mail info@lynx-technik.com

LYNX Technik manufactures a complete range of high quality modular products for broadcast and Professional markets, please contact your local representative or visit our web site for more product information.



This page is intentionally left blank

